



Désignation		Code constructeur	Ref FHS
<p>Coffret de commande adaptable version standard - gamme traditionnelle - ouverture assistée</p>		<p>ANTEODHOLLANDIAERHEL HEL HYDRISMBB INTERMICSORENSENZEPRO</p>	<p>3018024H </p>
<p>Coffret de commande adaptable version standard - gamme rétractable</p>		<p>ANTEODHOLLANDIAERHEL HEL HYDRISMBB INTERMICSORENSENZEPRO</p>	<p>3018025H </p>
<p>Coffret de commande adaptable version standard - gamme repliable</p>		<p>ANTEODHOLLANDIAERHEL HYDRISMBB INTERMICSORENSENZEPRO</p>	<p>3018026H </p>
<p>Coffret de commande adaptable version standard - gamme traditionnelle</p>			<p>3018027H </p>
<p>Coffret de commande adaptable version incl.auto au sol - gamme traditionnelle-ouverture assistée</p>		<p>ANTEODHOLLANDIAERHEL HEL HYDRISMBB INTERMICSORENSENZEPRO</p>	<p>3018029H </p>
<p>Coffret de commande adaptable version incl.auto au sol - gamme rétractable</p>			<p>3018030H </p>
<p>Coffret de commande principale</p>		ZEPRO	3018059G
<p>Coffret de commande principal</p>		ZEPRO	3018073G



Désignation	Code constructeur	Ref FHS
Coffret de commande principal	 ZEPRO	3018086G



Désignation		Code constructeur	Ref FHS
Commande encastrable 3 boutons commande équipée (faisceaux + connecteurs)		ANTEO	3018106G
Commande encastrable 1 bouton		ANTEO	3018123G
Emetteur de commande radio 2 canaux		ANTEO	3019336G
Commande annexe 2 boutons commande aimantée			3019346ANTEO 
Commande annexe 2 boutons commande aimantée			3019346ZEPRO 
Commande annexe 3 boutons commande aimantée			3019347ANTEO 
Commande annexe 3 boutons commande aimantée- version F3		ANTEO	3019347ANTEOF 
Commande annexe 3 boutons commande aimantée			3019347ZEPRO 



Désignation		Code constructeur	Ref FHS
Commande extra plate 2 boutons		ANTEO	3019382G
Commande annexe 3 boutons équipée commande+support+aimant		ANTEO	3019407G
Commande annexe 2 boutons équipée commande+support		ANTEO	3019415G
Emetteur de commande radio emetteur 4 canaux		ANTEO	3019503G
Boitier de commande annexe 2 boutons boitier aimanté + contacts			3023086B 
Boitier de commande annexe 3 boutons boitier aimanté + contacts			3023087B 





Désignation		Code constructeur	Ref FHS
		ANTEO	
Relais 24 volts - 15 Ampères		ANTEO	3015014G
Carte 3 relais sans les relais		ZEPRO	3022006G
Carte 3 relais		ZEPRO	3022006H 
Circuit imprimé 5 relais sans les relais		ZEPRO	3022029C
Carte imprimé 5 relais sans les relais		ZEPRO	3022029G
Carte imprimée 7 relais		ZEPRO	3022031C
Carte imprimée 7 relais		ZEPRO	3022031G



Désignation		Code constructeur	Ref FHS
Carte électronique à borniers		ZEPRO	3022035G
Platine de commande 3 relais 24volts		ANTEO	3022037G
Carte électronique 12 volts carte 3 relais - 60x120mm		ZEPRO	3022057C
Carte électronique 12 volts 3 relais 60x105		ZEPRO	3022057G
Platine de commande 4 relais 24volts		ANTEO	3022058G
Platine de commande 4 relais 24volts		ANTEO	3022058H
Platine de commande 4 relais 12 volts		ANTEO	3022075G
Platine de commande 4 relais 12volts		ANTEO	3022075H

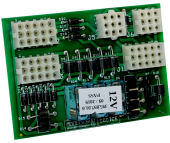

Désignation		Code constructeur	Ref FHS
Carte à 2 relais		ZEPRO	3022091G
Platine de commande 3 relais 12volts		ANTEO	3022104G
Carte imprimée 7 relais		ZEPRO	3022106G











Désignation		Code constructeur	Ref FHS
Manocontact pression + faisceau contact NF - pression 60bars - filetage 1/4BSP		ZEPRO	2210010G
Manocontact 310 bars + faisceau faisceau 2x1 Lg 3800mm		ZEPRO	2210024G
Relais 30A 5 broches (87a - 87)		DHOLLANDIA ZEPRO	3015011C
Relais 24 volts 5 broches		ZEPRO	3015024G
Centrale clignotante		ANTEO	3016004G
Centrale clignotante		ANTEO	3016008G
Capteur de position 2 fils		ANTEO HYDRIS MBB INTER	3017003G
Capteur de position 2 fils version alternative		ANTEO ERHEL HYDRIS MBB INTER	3017003H



Désignation		Code constructeur	Ref FHS
Capteur de proximité 3 fils		ANTEO	3017016G
Detecteur de proximite 3 fils		ANTEO	3017016H
Commande au pied à contact equipé contact 1xN.O. - IP66 - Øcoupelle ext 78mm -		ZEPRO	3020006H
Boitier adaptateur commande à distance 12v		ANTEO	3023099G
Tête de bouton + support		ZEPRO	3024032H
Contact 1 fonction (rouge) 1 contact N.O.		ANTEO	3026008H
Contact 1 fonction 1 contact N.O.		ANTEO	3026009H
Contact 1 fonction 1xNF		ZEPRO	3026011H



Désignation		Code constructeur	Ref FHS
Contact 1 fonction 1xN.O.		ZEPRO	3026012H
Contact de commande au pied (montée)		ANTEO	3026039C
Contact commande au pied (montée)		ANTEO	3026039G
Contact de commande au pied (intermédiaire)		ANTEO	3026040C
Contact de commande au pied (intermédiaire)		ANTEO	3026040G
Contact de commande au pied (descente)		ANTEO	3026041C
Contact de commande au pied (descente)		ANTEO	3026041G
Bouton poussoir pour commande au pied		ZEPRO	3027019C



Désignation		Code constructeur	Ref FHS
Micro interrupteur		ZEPRO	3027019G
Bouton poussoir équipé 1 fonction		ANTEO	3027033H
Bouton poussoir équipé 1 fonction		ANTEO	3027035H
Inverseur 3 positions 1 rappel auto à 0		ANTEO	3028008H
Bouton inverseur 2 positions 1 retour auto		ZEPRO	3028050G
Bouton inverseur 2 positions 1 retour auto		ZEPRO	3028050H
Inverseur 4 positions 1 retour auto		ANTEO	3028051H
Manipulateur 4 positions (4x1F)		ANTEO	3029024H



Désignation		Code constructeur	Ref FHS
Coupe batterie à clé		ANTEO ERHEL HYDRIS ZEPRO	303002C
Coupe batterie à clé 150A		DHOLLANDIA ZEPRO	303004C
Voyant de coffret		ANTEO	331006G
Feu de plateforme à leds		ANTEO	3311013G
Feu de plateforme version alternative 12 ou 24 volts		ANTEO	3311013H 
Feu de plateforme à leds feu sans fil doté d'une batterie			3311037H
Feu de plateforme à leds à encastrer Feu sans fil doté de 6 leds (3 sur 2 faces) Coquille de protection en zamak - IP68			3311044H 



Désignation		Code constructeur	Ref FHS
Boitier adaptateur de commande à distance		ANTEO	3023091G
Prise femelle 7 broches embase alu		ANTEO ERHEL HYDRIS	3110002
Prise DIN Hirschman		ANTEO DHOLLANDIA ERHEL HYDRIS	3110007
Prise JT + cable		ZEPRO	3110054H
Faisceau Kostal M24 + M27 faisceau 4ml		ANTEO DHOLLANDIA ERHEL HYDRIS	3110065H 
Connecteur de puissance négatif		ZEPRO	3110070G
Connecteur de puissance positif		ZEPRO	3110071G
Faisceau Kostal M27		ANTEO	3110092G



Désignation		Code constructeur	Ref FHS
Cordon hélicoïdal 5x1mm extension 3.5ml		DHOLLANDIA ERHEL HYDRIS MIC	3133005H
Cordon hélicoïdal 4x0.75mm Lg 3500mm		DHOLLANDIA ZEPRO	3133006H
Cordon hélicoïdal 5 x1mm² 290mm+500mmspiralé+2500lisse		ZEPRO	3133009H
Cable puissance masse + connecteur Lg1700mm		ZEPRO	3135015G
Cable puissance positif + connecteur Lg1700mm		ZEPRO	3135016G
Cordons extensibles de puissance 35mm² Lg extension 3500mm équipés de 2 prises 3110003			3136014
Faisceau équipé de carte Lg 1900mm		ZEPRO	3137055G
Faisceau équipé de groupe Lg1250mm		ZEPRO	3137056G



Désignation	Code constructeur	Ref FHS
Câble d'alimentation 7 x 1.5 Lg 4 ml + connecteur femelle Liaison carte gestion > coffret de commande	ZEPRO	3137101G







Désignation		Code constructeur	Ref FHS
Porte fusible de commande		ANTEO DHOLLANDIA	3119010H
Porte fusible puissance equipe fusible 250A		ANTEODHOLLANDIA ERHEL HYDRISMBB INTERMICZEPRO	3119030H 
Porte fusible puissance nu version universelle-EA50à60mm		DHOLLANDIA	3119031H 
Fusible de puissance 160A sans porcelaine		ZEPRO	3210012
Fusible de puissance 250A type Méga		ANTEO DHOLLANDIA	3210014
Fusible de puissance 200A type Méga		ANTEO	3210015
Fusible de puissance 250A sans porcelaine		DHOLLANDIA ZEPRO	3210031











Désignation		Code constructeur	Ref FHS
Commande principale nue		ANTEO	4114041G
Couvercle de commande principale (Lg332xHt170xProf60mm)		ANTEO	4114050G
Couvercle de commande principale		ANTEO	4114077G
Couvercle de commande principale		ZEPRO	4114104G
Fonds de commande principale		ZEPRO	4114170G



Désignation		Code constructeur	Ref FHS
Façade de commande principale		ZEPRO	4114205G
Façade de commande principale		ZEPRO	4114220G



Autres

Désignation		Code constructeur	Ref FHS
Coiffe de bouton poussoir		DHOLLANDIA ZEPRO	3024017H
Support carte de gestion		ZEPRO	4010502G
Couvercle de commande principale		ZEPRO	4114145G
Fonds de commande principale		ZEPRO	4114241G
Support commande annexe		ZEPRO	4115066G
Support capteur de proximité		ANTEO	4122025G
Support coffret de commande		ANTEO	4122039G
Support commande annexe		ANTEO	5010022G





Autres

Désignation		Code constructeur	Ref FHS
Kit serrure coffret de commande		ANTEO	5012019G
Verrou coffret de commande		ZEPRO	5012020G
Taquet de verrou		ZEPRO	5012021G
Charniere coffret de commande		ZEPRO	5013034G
Vis (fond coffret 4114241G)		ZEPRO	5115026G
Adhesif consigne utilisation retractable		ZEPRO	5414157G
Adhesif abaque de charge 1500 DaN grand format		ZEPRO	5414159G
Adhesif interdiction zone 300mm		ZEPRO	5414161G



Autres

Désignation		Code constructeur	Ref FHS
Adhesif abaque de charge 1000 DaN		ANTEO	5414201G
Adhesif Cde pour coffret 6 boutons		ZEPRO	5417024G



Relais

Désignation		Code constructeur	Ref FHS
Relais 24V 80 A 2 broches		ERHEL HYDRIS MBB INTER MIC	3012006H
Relais moteur 12V 80 A		ANTEO DHOLLANDIA ERHEL HYDRIS	3012007H
Relais moteur 24V 80 A		ANTEO DHOLLANDIA ERHEL HYDRIS	3012008H
Relais moteur 24V 150 A version adaptable		ANTEO DHOLLANDIA ERHEL HYDRIS	3012022C
Relais moteur 24V 150 A		ANTEO DHOLLANDIA ERHEL HYDRIS	3012022H
Relais moteur 24V		SORENSEN ZEPRO	3012039H
Relais moteur 12V		SORENSEN ZEPRO	3012054C
Relais moteur 12V 200 A		SORENSEN ZEPRO	3012054G



Relais

Désignation	Code constructeur	Ref FHS
Relais moteur 24V 100A	ZEPRO	3012057H





Désignation		Code constructeur	Ref FHS
<p>Moteur électrique 12 volts moteur bipolaire 1500W rotation à droite empreinte femelle</p>		DHOLLANDIA ERHEL HYDRIS MIC	3010013
<p>Moteur électrique 12 volts version optimisée -moteur bipolaire 1500Watts-rotation à droite (face arbre)- empreinte femelle</p>		DHOLLANDIA ERHEL HYDRIS MIC	3010013H 
<p>Moteur électrique 24 volts moteur bipolaire 2200 Watts - rotation à droite (face arbre)</p>			3010014
<p>Moteur électrique 24 volts moteur bipolaire 2200 Watts - rotation à droite</p>		DHOLLANDIA ZEPRO	3010014C
<p>Moteur électrique 24 volts version optimisée-moteur bipolaire 2200watts- rotation à droite (face arbre)</p>		DHOLLANDIA ERHEL HYDRIS MIC	3010014H 
<p>Moteur électrique 24 volts moteur bipolaire 24v - 3000W - rotation a droite - empreinte femelle</p>		DHOLLANDIA HYDRIS MIC	3010018C
<p>Moteur électrique 24 volts moteur bipolaire 24v - 3000W rotation à droite empreinte femelle</p>		DHOLLANDIA HYDRIS MIC	3010018H
<p>Moteur électrique 12 volts puissance 800W - Rotation gauche CCW</p>		DHOLLANDIA MBB INTER ZEPRO	3010071C



Moteurs

Désignation		Code constructeur	Ref FHS
<p>Moteur électrique 12 volts puissance 800W - Rotation a gaucheCCW</p>		DHOLLANDIA MBB INTER ZEPRO	3010071H
<p>Moteur electrique 12 volts 2000W</p>	<p>francehayon</p>	ANTEO	3010080G
<p>Moteur electrique 12 volts 2000w moteur bipolaire 2000W (voir positionnement flasque avant)</p>		ANTEO	3010080H
<p>Moteur électrique 12 volts moteur bipolaire 2000 watts rotation à droite empreinte mâle</p>		ANTEO ERHEL HYDRIS MBB INTER	3010082H
<p>Moteur électrique 24 volts moteur bipolaire 2000 Watts rotation a droite empreinte male</p>		ANTEO ERHEL HYDRIS MBB INTER	3010083C
<p>Moteur électrique 24 volts moteur bipolaire 800watts rotation à droite</p>		DHOLLANDIA MBB INTER ZEPRO	3010088H
<p>Moteur électrique 12 volts moteur bipolaire 800watts - rotation a gauche</p>		MBB INTER SORENSEN ZEPRO	3010104H
<p>Moteur électrique 24 volts moteur bipolaire 1200W rotation à gauche empreinte femelle</p>		SORENSEN ZEPRO	3010109G



Moteurs

Désignation		Code constructeur	Ref FHS
<p>Moteur électrique 24 volts moteur bipolaire 2000watts rotation à gauche</p>		<p>ERHEL HYDRIS MIC SORENSEN</p>	3010142H
<p>Moteur électrique 12volts moteur bipolaire 1500watts- rotation à gauche (face arbre) - empreinte femelle - sans flasque</p>		<p>SORENSEN ZEPRO</p>	3010144C
<p>Moteur électrique 12volts moteur bipolaire 1500watts- rotation à gauche (face arbre) - empreinte femelle - sans flasque</p>		<p>SORENSEN ZEPRO</p>	3010144H
<p>Moteur électrique 24volts moteur bipolaire 2000Watts rotation à gauche empreinte cannelée</p>		<p>ZEPRO</p>	3010145C
<p>Moteur électrique 24 volts moteur bipolaire 2000W rotation à gauche empreinte cannelée</p>		<p>ZEPRO</p>	3010145H
<p>Moteur électrique 12 volts 2000Watts rotation a gauche - arbre femelle cannele</p>		<p>ZEPRO</p>	3010153C
<p>Moteur électrique 24 volts + relais moteur bipolaire 2200W avec protection thermique</p>		<p>ANTEO</p>	3010188G
<p>Moteur électrique 24 volts + relais moteur bipolaire 2200W + protection thermique !!! (voir positionnement flasque avant)</p>		<p>ANTEO</p>	3010188H



Désignation	Code constructeur	Ref FHS
Jeu de 4 balais moteur équipé 16x9x18mm - pour moteur ISKRA	ANTEO ERHEL HYDRIS	3011042
Jeu de balais 20x9x22mm - pour moteur électrique Haldex	ERHEL HYDRIS SORENSEN ZEPRO	3011049H

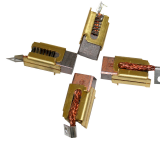









Désignation		Code constructeur	Ref FHS
Pompe à engrenages 0.75 Cm3/tr arbre 2 méplats		ZEPRO	1010033H
Pompe à engrenages 1.1 Cm3/tr version adaptable - rotation a gauche		ANTEO MBB INTER	1010041C
Pompe à engrenages 1.2 Cm3/tr arbre cannelé		ZEPRO	1010068G
Pompe à engrenages 1.2 Cm3/tr version alternative-arbre cannelé-équipée kit crepine		ZEPRO	1010068H
Pompe à engrenages 1.6 Cm3/tr version adaptable		ANTEO	1010074C
Pompe à engrenages 1.6 Cm3/tr		ANTEO	1010074G
Pompe à engrenages 2.5 Cm3/tr version alternative équipée - arbre cannelé - équipée vis + kit aspiration		ZEPRO	1010076H
Pompe à engrenages 2.6 Cm3/tr arbre à méplats-rotation à gauche		ANTEO	1010080H



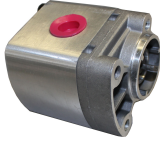



Désignation		Code constructeur	Ref FHS
Pompe à engrenages 0.8 Cm3/tr version adaptable-arbre cannelé		ZEPRO	1010093C
Pompe à engrenages 1.2 Cm3/tr version alternative équipée		ZEPRO	1010098H
Pompe à engrenages 1.63 Cm3/tr version adaptable 1.6cm3/tr arbre à méplats		ZEPRO	1010099C
Pompe à engrenages		ANTEO	1010112H
Pompe à engrenages 0.75 Cm3/tr version alternative équipée		ZEPRO	1010114H
Pompe à engrenages 1.63 Cm3/tr type2		ANTEO	1010204G
Pompe à engrenages 1.6 Cm3/tr type2- version optimisee		ANTEO	1010204H
Pompe à engrenages 2.5 Cm3/tr version alternative		ZEPRO	1010208C



Désignation		Code constructeur	Ref FHS
Pompe à engrenages 3.2 Cm3/tr version alternative		ZEPRO	1010209C
Interface de pompe équipée ZS200		ZEPRO	1013035G
Interface de pompe équipée		ZEPRO	1116011C
Interface de pompe équipée		ZEPRO	1116011G
Bloc interface de pompe		ANTEO	1116023G



Désignation		Code constructeur	Ref FHS
Bloc alu support valve en L pour valve 3/4 16UNF			1115038H
Bloc alu support valve 56x38x30		ZEPRO	1115053G
Electro distributeur 4/2		ANTEO	2110015
Bloc + électro-vanne 24volts équipé		ZEPRO	2111121G
Bloc + électro-vanne 24volts équipé		ZEPRO	2111121H
Bloc distributeur 24volts 3 electros équipé REP15		ANTEO	2111126G
Bloc distributeur + valves 24V		ZEPRO	2111130G
Electro-vanne VLB 20X150 12 volts electro non debrayable - nezØ15-corpsØ18mm - connectique kostal M27		ANTEO ERHEL HYDRIS	2112127H



Désignation	Code constructeur	Ref FHS
Electrovanne 4/3 24volts (dble bobine) pour moteur hydraulique Ønez 13mm - tige13mm	ZEPRO	2112159G
Electrovanne 4/3 24volts (dble bobine) Ønez 13mm-Øtige 13mm	ZEPRO	2112159H 
Electro-vanne VNF 3/4-16UNF 24 volts nez Ø13mm - connectique Junior Time	ZEPRO	2112198H
Electro-vanne VLB 3/4-16 UNF 12volts nez de 13 connectique Kostal M27	ANTEO	2112203G
Electro-vanne VLB 3/4-16 UNF 12 volts nez de 13mm connectique Kostal M27	ANTEO	2112203H
Electrovanne VNF 24 volts G3/4-16UNF Ønez12.7 KostalM27	ANTEO	2112205G
Electrovanne VNF 24volts G3/4-16UNF Ønez12.7 Kostal M27	ANTEO	2112205H
Electrovanne VNF 24 volts G3/4-16UNF Ønez12.7 KostalM27 débrayable	ANTEO	2112210G



Désignation	Code constructeur	Ref FHS
<p>Electrovanne VLB 24volts G3/4-16UNF - nezØ12.7- KostalM27</p>	ANTEO	2112212G
<p>Electrovanne VLB 24volts G3/4-16UNF - nezØ12.7mm -KostalM27-débrayable</p>	ANTEO	2112212H
<p>Electro-vanne VLB 3/4-16 UNF 24v nez Ø13mm-connectique DIN</p>	ANTEO	2112215H
<p>Electro-vanne 4/2 M22x150 24volts connectique DIN</p>	ANTEO	2112218G
<p>Electrovanne VNF 3/4-16UNF 24volts Ønez 13mm - Øcorps15mm- connectique Kostal M27</p>	ANTEO	2112226H



Désignation		Code constructeur	Ref FHS
Distributeur 2/2 VNF 3/4-16 UNF Ø16		ZEPRO	1020011H
Distributeur 2/2 VNF 3/4-16UNF Ø nez 12.9 - débrayable		ANTEO DHOLLANDIA ZEPRO	1020018H
Distributeur 2/2 VLB 3/4-16UNF Ø nez 12.7mm - débrayable		ANTEO DHOLLANDIA ZEPRO	1020019H
Distributeur VNF 2/2 3/4-16UNF nez de Ø15.8mm		ANTEO	1020029H
Distributeur 4/3-3/4 16UNF Ø de nez 13		ANTEO	1020043H
Distributeur 4/3 - 3/4 16UNF Ø de nez 13 - centre fermé		DHOLLANDIA ZEPRO	1020053H
Distributeur 3/2 - M22 x ...- d16 - débrayable		ZEPRO	1020055C
Distributeur 2/2 VLB 3/4-16UNF Ø nez 16mm débrayable		ZEPRO	1020059H



Désignation	Code constructeur	Ref FHS
Distributeur 4/2 Ønez 16mm débrayable	ZEPRO	1020060H
		
Distributeur VNF 3/4 nez Ø13	ZEPRO	1020066G
		
Distributeur 2/2 VLB 3/4 16 UNF Ønez 12.7mm - Øcorps 13mm	ZEPRO	1020068G
		









Désignation		Code constructeur	Ref FHS
Bobine EM15 24V		DHOLLANDIA ERHEL HYDRIS MBB INTER	3013004H
Bobine 12V Ø13 DIN connecteur Hirschman		ANTEO ERHEL HYDRIS	3014023H
Bobine 24V Ø13 DIN connecteur Hirschman		ANTEO	3014024H
Bobine 12V Ø13 Kostal M24 ht39mm		ANTEO DHOLLANDIA	3014025H
Bobine 24V Ø16 H 50 DIN		ANTEO	3014050H
Bobine 24V Ø16 H 50 Filaire		ZEPRO	3014057G
Bobine 24V Ø16 H 50 Filaire équipée		ZEPRO	3014057H
Bobine 24V Ø18 H 40 Kostal M27		ANTEO DAUTEL	3014070H



Désignation		Code constructeur	Ref FHS
Bobine 24V Ø13 H 38.5 Kostal M27		ANTEO	3014074C
Bobine 12V Ø13 H 38.5 Kostal M27		ANTEO	3014075C
Bobine 24V Ø13 H 39 connecteur junior time		ZEPRO	3014076C
Bobine 24V Ø16 H 52 connecteur junior time		ZEPRO	3014077C
Bobine 12V Ø13 H 39 connecteur Junior Time		ZEPRO	3014080C
Bobine 12V Ø16 H 52 connecteur Junior Time		ZEPRO	3014081C
Bobine 12V Ø18 Kostal M27 Ht 40mm		ANTEO	3014082H
Bobine 12V Ø14 H 40 DIN		ANTEO	3014095G



Désignation		Code constructeur	Ref FHS
Bobine 12V Ø22 H 55 DIN		ANTEO	3014098G
Bobine 24V connecteur Junior Time Øint 13mm - pour verin de retraction		ZEPRO	3014103C
Bobine 24V connecteur Junior Time Ø13int - pour verin de retraction		ZEPRO	3014103G
Bobine 24V connecteur Junior Time Øint13mm - Pour valve vérin de rétraction		ZEPRO	3014105C
Bobine 24V connecteur Junior time Øint13mm pour valve vérin de rétraction		ZEPRO	3014105G
Bobine 24V Ø13 Filaire ht36mm		ZEPRO	3014122H
Bobine 12volts Ø13 filaire connexion Junior Time		ZEPRO	3014124G



Désignation	Code constructeur	Ref FHS
Moteur hydraulique MP 250 cc3	ZEPRO	1021002C
Moteur hydraulique	ANTEO	1021006C
Set de joints pour moteur hydraulique	DHOLLANDIA ZEPRO	5218186C



Désignation		Code constructeur	Ref FHS
Réservoir carré 250x250x117		ZEPRO	1110049G
Reservoir ensemble equipe collier,crepine,bouchon- Lg350mm		ZEPRO	1110080C
Réservoir ensemble equipe collier,crepine,bouchon-Lg350mm		ZEPRO	1110080G
Réservoir ensemble equipe - Lg390mm		ZEPRO	1110083G
Reservoir ensemble equipe - Lg390mm		ZEPRO	1110083H
reservoir tôle F2AB		ANTEO	1110089G
Reservoir SZH		ZEPRO	1110111C
Réservoir SZH		ZEPRO	1110111G





Désignation		Code constructeur	Ref FHS
reservoir tôle F3CL - F3RE		ANTEO	1110121G
Reservoir inox F3CL Matiere: Inox brut passive - 315x300x270mm		ANTEO	1110121H 
Reservoir equipe 160x145x160 - Ø85mm		ZEPRO	1110131G
Réservoir ZT25 ensemble equipe collier,crepine,bouchon		ZEPRO	1110146C
Reservoir equipe 265x210x155mm		ANTEO	1110147G
Reservoir equipe 265x210x155mm		ANTEO	1110147H



Désignation		Code constructeur	Ref FHS
Capot de groupe Gamme F2 - Ht388x324xP280mm		ANTEO	4114038G
Capot de groupe gamme F3 Lg325mmxht305xpf165mm		ANTEO	4114136G
Capot de groupe Lg280mmxht345mmxpf285mm		ANTEO	4114137G
Capot de groupe gamme F2		ANTEO	4114152G
Capot de groupe équipé 375x210x215mm		ZEPRO	4114164G
Capot de groupe equipe 260x220xht265		ZEPRO	4114168G
Capot de groupe 490x255x230mm		ANTEO	4114176G
Capot de groupe		ANTEO	4114201G



Désignation		Code constructeur	Ref FHS
Capot de groupe Lg285xHt285xpf225mm		ANTEO	4114208G
Capot de groupe hydraulique		ZEPRO	4114257G













Désignation		Code constructeur	Ref FHS
Filtre d'aspiration		ZEPRO	1111009G
Crépine d'aspiration		ERHEL HYDRIS ZEPRO	1111012H
Crepine d'aspiration		SORENSEN ZEPRO	1111015H
Tube aspiration		ZEPRO	1111017G
Durite de retour au réservoir		ZEPRO	1113003G
Bloc de distribution té coupleur		ZEPRO	1115082G
Flexible aspiration groupe D20mm-d12mm Lg330mm		ANTEO	1123137G
Flexible retour groupe D21mm-d13mm - Lg200mm		ANTEO	1123138G



Désignation		Code constructeur	Ref FHS
Bouchon de réservoir Ø30x30mm - pas1/2BSP		ERHEL HYDRIS ZEPRO	1126010H
Filtre		ANTEO	1126038G
Filtre d'aspiration		ANTEO ERHEL HYDRIS MBB INTER	1126040H
Bouchon de réservoir+jauge		ANTEO	1126041G
Noix entraînement moteur-pompe FF Ø22H12			1127015H
Noix accouplement moteur - pompe Ø18H32		ANTEO	1127017G
Noix accouplement moteur-pompe Ø18H32 Lg32mm - femelle-femelle		ANTEO ERHEL HYDRIS	1127017H
Soupape de compensation		ZEPRO	1211018G











Désignation	Code constructeur	Ref FHS
Attache caoutchouc	ANTEO	5010014G
		
Attache métal	ANTEO	5010021G
		
Attache caoutchouc pour capot F3	ANTEO	5010024C
		
Attache caoutchouc pour capot F3 gamme F3	ANTEO	5010024G
		
Attache métallique	ZEPRO	5010030H
		
Joint plat de reservoir pour reservoir 1110049		5231266G
		
Joint metalloplastique D24mm-d15mm-ep2.5mm	ANTEO	5231502G
		
Joint etancheite centrale- poutre	ZEPRO	5231511G
		



Désignation	Code constructeur	Ref FHS
Joint de réservoir (kit)	ZEPRO	601111H





Désignation	Code constructeur	Ref FHS
Verin de levage DE Ø45x70mm	ZEPRO	1015007C
		
Vérin de levage DE Ø45x70mm	ZEPRO	1015007G
		
Vérin de levage SE Ø45x70 C245mm EAF554mm - equipe tete a visser pour M35	ZEPRO	1015180H
		
		
Vérin de levage DE Ø45x80mm EAF550mm 2 passages axe Ø30mm	ZEPRO	1015186C
		
Vérin de levage DE Ø45x80mm EAF590mm 2 passages axe Ø30mm	ZEPRO	1015186G
		
Vérin de levage DE Ø45x80mm EA520mm	ZEPRO	1015198G
		
Verin de levage DE Ø35x65mm EAF750mm	ZEPRO	1015219C
		
Vérin de levage DE Ø35x65mm EAF750mm	ZEPRO	1015219G
		



Désignation	Code constructeur	Ref FHS
Vérin de levage gauche	ANTEO	1015239G
		
Vérin de levage	ANTEO	1015242G
		
Verin de levage equipe DE Ø55x35mm C230mm EAF475mm - axe Ø25mm	ZEPRO	1015249C
		
Vérin levage équipe D.E. Ø55x35mm C230mm EAF475mm pour axes Ø25mm	ZEPRO	1015249G
		
Vérin de levage DE Ø45x70mm C305mm EAF540mm	ZEPRO	1015268G
		
Verin de levage SE Ø80mm Ø45X80mm C305mm EAF545mm	ZEPRO	1015278G
		
Vérin de levage SE Ø80 Ø45XØ80 C305 EAF 545mm bsp3/8 - gamme ZT25-140	ZEPRO	1015278H
		
Vérin de levage equipe DE Gamme F3 20/22 - cote gauche - Ø40x70 C275mm	ANTEO	1015291H
		







Désignation	Code constructeur	Ref FHS
<p>Vérin de levage équipé DE Gamme F3 20/22 - cote droite - Ø40x70 C275mm</p>	<p>ANTEO</p> 	<p>1015292H </p>
<p>Verin de levage SE Ø35X65mm- EAF640mm</p>	<p>ZEPRO</p> 	<p>1015310G</p>
<p>Verin de levage SE Ø35x65mm C305mm EAF628mm- equipe tete a visser M20 pas200 Lg148mm</p>	<p>ZEPRO</p> 	<p>1015310H </p>
<p>Verin de levage DE Ø45X70mm EAF630mm equipe passage axesØ35mm</p>	<p>ZEPRO</p> 	<p>1015324G</p>
<p>Verin de levage DE cote droite - Ø40x60mm C275mm</p>	<p>ANTEO</p> 	<p>1015505G</p>
<p>Vérin de levage DE cote droite - Ø40X60mm C275mm</p>	<p>ANTEO</p> 	<p>1015505H </p>
<p>Vérin de levage DE cote gauche - Ø40x60mm C275mm</p>	<p>ANTEO</p> 	<p>1015506G</p>
<p>Verin de levage DE cote gauche - Ø40x60mm C275mm</p>	<p>ANTEO</p> 	<p>1015506H </p>



Désignation	Code constructeur	Ref FHS
Vérin de levage equipe S.E. Ø45x80 EAF 600mm (SZH)	ZEPRO	1015521G
Vérin de levage DE Ø35x65MM C305mm EAF628mm- equipe tete a visser M20 pas200 Lg148mm	ZEPRO	1016117H 
Vérin de levage DE Ø35x65mm C305mm - EAF523mm - equipe tete a visser M20 Lg43mm	ZEPRO	1016183H 
Vérin de levage DE Ø45x70 EAF750mm - Z 250-155	ZEPRO	1016232C

francehayon



Désignation	Code constructeur	Ref FHS
Verin inclinaison equipe DE Ø45x70mm EA 785mm - pour BZ-RZ15 A News	ZEPRO	1015021C
		
Verin inclinaison equipe verin DE Ø45x70mm EAF835mm -BZ RZ15 A News	ZEPRO	1015021G
		
Vérin d'inclinaison droit	ANTEO	1015034G
		
Verin inclinaison DE Ø35x55 EA644mm	ZEPRO	1015206C
		
Vérin d'inclinaison gamme F3M075C/H	ANTEO	1015229G
		
Vérin d'inclinaison SE 45X80 C245mm EAF845mm	ZEPRO	1015236H
		
Verin inclinaison SE Ø45x70mm EA730mm	ZEPRO	1015259C
		
Verin inclinaison SE45x70 C348mm EAF785mm	ZEPRO	1015260H
		



Désignation	Code constructeur	Ref FHS
Vérin d'inclinaison coté gauche pour F3CL15H	ANTEO	1015261G
		
verin inclinaison D.E.	ZEPRO	1015276G
		
Vérin d'inclinaison DE 40X80 coté gauche	ANTEO	1015293C
		
Vérin d'inclinaison DE 40X80 coté gauche	ANTEO	1015293G
		
Verin inclinaison DE Ø45x80mm EA905mm	ZEPRO	1015302C
		
Verin inclinaison DE Ø45x80mm EA905mm	ZEPRO	1015302G
		
Verin inclinaison SE Ø30X50+M27 EAF470mm	ANTEO	1015304G
		
Verin inclinaison DE 45x90 EAF840mm	ZEPRO	1015313C
		



Désignation	Code constructeur	Ref FHS
Verin inclinaison DE 45x90 EAF840mm	ZEPRO	1015313G
		
Verin d'inclinaison D.E. F3M075 35X70mm + M30 mâle - EAF ss rallonge 550mm	ANTEO	1015316G
		
verin inclinaison D.E. Ø35X55mm EAF640mm equipe	ZEPRO	1015327C
		
verin inclinaison D.E. equipe Ø55mm EAF640mm	ZEPRO	1015327G
		
verind' inclinaison S.E. equipe Ø45x80mm EAF785mm	ZEPRO	1015335G
		
Verin d'inclinaison S.E. equipe verin Ø45x80mm EAF785mm	ZEPRO	1015335H 
		
verin inclinaison D.E. verin DE Ø45X80mm EAF980mm - equipe tenon orientable + rallonge réglable	ZEPRO	1015338H 
		
verin inclinaison D.E.	ANTEO	1015343G
		



Désignation	Code constructeur	Ref FHS
verin inclinaison D.E. Ø35X55mm EAF650mm equipe	ZEPRO	1015372G
Verin inclinaison DE Ø45x80mm EA824mm	ZEPRO	1015507C
france hayon		
Verin inclinaison DE Ø45x80mm EA824mm	ZEPRO	1015507G
france hayon		
Vérin d'inclinaison DE40X80 coté droite	ANTEO	1015528C
france hayon		
Vérin d'inclinaison DE40X80 coté droite	ANTEO	1015528G
Vérin d'inclinaison DE 45x80 C225 EAF845	ZEPRO	1016146H
Vérin d'inclinaison DE 45x80 C75mm EAF845mm	ZEPRO	1016155H
Vérin d'inclinaison D.E. 45x80 C85mm EAF785mm équipé	ZEPRO	1016187H













Désignation	Code constructeur	Ref FHS
verin inclinaison Ø45x80mm EAF700mm	ZEPRO	1016199C
verin inclinaison D.E. 35x65 EAF 510mm	ZEPRO	1016215G
Vérin d'inclinaison	ANTEO	1016513G













Désignation	Code constructeur	Ref FHS
Pochette de joints Ø45x70mm francehayon	ZEPRO	5218019C
Pochette de joints Ø35x55 pour V.L. et V.F.	ZEPRO	5218041C
Pochette de joints 35x55 pour V.L. et V.F.	ZEPRO	5218041G
Pochette de joints 35x55 pour V.F.	ZEPRO	5218108C
Pochette de joints Ø45xØ70mm	ANTEO	5218135C
Pochette de joints Ø45xØ70mm	ANTEO	5218135G
Pochette de joints 40x70 pour V.L.	ZEPRO	5218138G
Pochette de joints 40x70mm pour V.L.	ZEPRO	5218138H





Désignation		Code constructeur	Ref FHS
Pochette de joints 35x65 pour V.L.		ZEPRO	5218153H 
Pochette de joints Ø35X55mm		ZEPRO	5218162C
Pochette de joints Ø35X55mm		ZEPRO	5218162G
Pochette de joints 45x70mm pour VL		ZEPRO	5218163C
Pochette de joints Ø45x90mm		ZEPRO	5218171G
Pochette joints pour V.L. F3CL15		ANTEO	5218174G
Pochette de joints pour V.L. F3CL15 (version optimisée origine et alternative)		ANTEO	5218174H 
Pochette de joints Ø45XØ80 pour version origine et optimisé Hydem		ZEPRO	5218175H 



Désignation		Code constructeur	Ref FHS
Pochette de joints Ø45x80mm		ZEPRO	5218182C
Pochette de joints Ø45xØ80mm		ZEPRO	5218182G
Pochette de joints pour VL en Ø70mm		ZEPRO	5218196C
Pochette de joints pour VL en Ø70mm		ZEPRO	5218196G
Pochette de joints 40x70		ANTEO	5218207C
Pochette de joints 40 x70		ANTEO	5218207G
Pochette de joints		ZEPRO	5218238G
Pochette de joints Ø45x80mm			5218238H 



Désignation		Code constructeur	Ref FHS
Pochette de joints V.L. pour CE15 REP		ANTEO	5218245C
Pochette de joints 40x80mm		ANTEO	5218250C
Pochette de joints 40x80mm		ANTEO	5218250G



Désignation		Code constructeur	Ref FHS
Vis banjo 1 sortie pas G1/4		ZEPRO	1122029
Rallonge vérin inclinaison Ø50mm-M35mm-Lg245mm-axe30mm		ANTEO	4012562G
Embout réglable de vérin M24 - Lg217mm - axeØ30mm		ZEPRO	4013006H 
Tirant de V.F. Ø25 Lg115mm à l'axe		ZEPRO	4013021G
Rallonge bague pour V.L.- EA100mm		ZEPRO	4013050G
Ecrou pour vérin inclinaison 40X80 Øext57mm-ep11mm		ANTEO	5119031G
Ecrou plat à ergots M30		ANTEO	5120007G
Ecrou à ergots pour vérin fermeture Ø52mm ext ep8mm		ANTEO	5122016G



Désignation		Code constructeur	Ref FHS
Rotule étanche Ø25mm Ø42/Ø25mm ep20mm		ZEPRO	5212001H
Rotule Øext47 - Øint30 ep18mm ped de vérin		ZEPRO	5212002H
Soufflet de protection verin Ø35x70mm - IG dépliement 220mm		ZEPRO	5226010C
Soufflet de protection verin Ø35x70mm		ZEPRO	5226010G
Soufflet de protection verin 50x90mm - pour V.L.		ANTEO	5226018G
Soufflet de protection verin 50x90mm debatement 250mm pour V.L.		ANTEO	5226018H
Soufflet de protection verin (long) pour BZZ		ZEPRO	5226021G
Soufflet de protection verin (court) Ø90/Ø40mm debat300mm		ZEPRO	5226022C









Désignation		Code constructeur	Ref FHS
Soufflet de protection verin (court) Ø90/Ø40 debat300MM - pour BZZ		ZEPRO	5226022G
Fourreau de verin d'inclinaison Ø40xØ80 Lg345mm		ZEPRO	5226028C
Soufflet de protection verin Ø40x60 80-300mm pour verin inclinaison		ANTEO	5226033C
Soufflet de protection verin Ø40x60 80-300mm pour verin inclinaison		ANTEO	5226033G
Bague de réduction de soufflet Ø80mm		ANTEO	5226036G
Bague de réduction de soufflet Ø70mm		ANTEO	5226037G
Soufflet de protection verin Ø45mmxØ70mm		ZEPRO	5226062G
Soufflet de protection verin Ø30X65mm - pour verin levage		ZEPRO	5226065C



Désignation		Code constructeur	Ref FHS
Soufflet Ø80 x 90		ZEPRO	5226077G
Ressort de vérin Ø70mm Lg150mm - filØ9mm		ZEPRO	5313008C
Ressort de vérin Ø70mm Lg150mm - filØ9mm		ZEPRO	5313008G
Ressort de vérin Ø37 x 51 Lg 200mm pour VI		ZEPRO	5313072C
Ressort de vérin Ø37 x 51 Lg 200mm pour VI		ZEPRO	5313072G
Ressort piston bloc valve		ZEPRO	5313171G









Désignation		Code constructeur	Ref FHS
Flexible HP 1/4 2bjos 1/4 Lg 850mm inclinaison banjos 24°		ZEPRO	1123037G
Flexible HP 1/4 2bjos 1/4 Lg 650mm inclinaison banjo 102°		ZEPRO	1123040G
Flexible HP 1/4 2bjos 1/4 Lg 650mm version alternative		ZEPRO	1123040H
Flexible HP 1/4 Lg 465mm FJ7/16+FJ7/16à90°			1123089H
Flexible 3/8 Lg 615mm 3/8 FJ9/16 + FJ9/16 à 90° Lg 615mm		ANTEO	1123092G
Flexible HP 3/8 Lg 670mm FJ9/16 + FJ9/16à90°		ANTEO	1123093G
Flexible HP 1/4 FJ9/16 + FJ9/16 à 90° Lg 800 mm		ANTEO	1123094H
Flexible HP Lg 560mm ETFJ9/16 + ETFJ16/16à90°		ANTEO	1123109H



Désignation		Code constructeur	Ref FHS
Flexible HP 1/4 Lg2000mm 2xFJ9/16à90°		ANTEO	1123111H
Flexible HP 1/4 Lg 920mm FJ9/16+FL9/16à90°		ANTEO	1123112H
Flexible HP3/8 Lg420mm FJ9/16+FJ9/16à90°		ANTEO	1123116G
Flexible HP 1/4 2bjos 1/4 Lg 1250mm		ZEPRO	1123179H
Flexible HP 1/4 ETM10 + ETM10 à 90° Lg710mm		ANTEO	1123218G
Flexible HP 1/4 BJ1/4 + BJ3/8 Lg 1050 mm		ZEPRO	1124039H
Flexible H.P. 2 banjos 1/4 Lg 500mm		ZEPRO	1124041H
Flexible H.P. 2 banjos 1/4 Lg 700mm		ZEPRO	1124042H



Désignation		Code constructeur	Ref FHS
Flexible H.P. 2 banjos Ø13 Lg700mm		ZEPRO	1124044H
Flexible H.P. 1banjo1/4 + 1banjo 3/8 Lg 500mm		ZEPRO	1124051H
Flexible H.P.3/8 1banjo 1/4 + 1banjo 3/8 Lg 550mm		ZEPRO	1124052G
Flexible H.P. 3/8 Lg 1070mm 2FBSP 3/8		ZEPRO	1124053G
Flexible H.P. 2 banjos 1/4 Lg 620mm		ZEPRO	1124056H
Flexible 1/4 Lg 1070mm 2FBSP1/4		ZEPRO	1124060H
Flexible H.P. 1 banjo 1/4 - 1banjo3/8 Lg 950mm		ZEPRO	1124061H
Flexible HP 1/4 2 FBSP1/4 Lg 1350 mm		ZEPRO	1124063H



Désignation		Code constructeur	Ref FHS
Flexible H.P. 3/8ème 2FBSP 1/4 Lg1400mm		ZEPRO	1124083G
Flexible H.P. 1 banjo 1/4 + 1 FBSP 1/4 Lg 890mm		ZEPRO	1125031H
Flexible HP 1/4 Lg320mm 2FJ9/16			1130025H



Désignation		Code constructeur	Ref FHS
Rampe distribution hydraulique Lg 1600mm		ZEPRO	1116041G
Raccord droit		ANTEO	1117060
Raccord hydraulique		ZEPRO	1117090G
Coude M/F 3/8 conique / 3/8ème cylindrique		ZEPRO	1118018C
Raccord coudé MM		ANTEO	1118025
Raccord air en Y Ø6mm filetage 1/8ème		ANTEO	1118029G
Coude raccord bjo 1/8ème pour flexible retour Ø6mm		ANTEO	1118035G
Raccord en té pour tuyau Ø6mm		ANTEO	1119027G



Désignation		Code constructeur	Ref FHS
Vis creuse 3/8 ème équipée parachute		ZEPRO	1122111G
Vis banjo 1 sortie 1/8ème-G.L.24		ANTEO	1122112G
Vis creuse 1 sortie 3/8eme BSP		ZEPRO	1122131C
Vis creuse 1 sortie 3/8eme BSP		ZEPRO	1122131G
Vis banjo		ANTEO	1122139G
Vis creuse double D.13 - 1/4 LG 43mm		ZEPRO	1122166G
Piston pour bloc valve		ZEPRO	1210027G
Bague métaloplastique Ø17 BS3/8		ANTEO DHOLLANDIA ZEPRO	5214004



Désignation		Code constructeur	Ref FHS
Kit event pour verin inclinaison		ANTEO	6011347G







Désignation		Code constructeur	Ref FHS
Piston de frein Ø30mm		ANTEO	1025003G
Entretoise de serrage		ANTEO	4010311G
Plaque fixation chaine de retraction		ZEPRO	4010527G
Support fixation chaine retraction		ZEPRO	4010592G
Tendeur de chaine acier zingue Ø15mm M12 Lg75mm		ZEPRO	4012203H
Pignon de rétraction 15 dents Ø25mm ep75mm pour ZT 2000		ZEPRO	4012255H
Pignon de rétraction 15 dents Ø25mm ep25mm pour ZT200		ZEPRO	4012332H
Bloquage de crémaillère		ANTEO	4012342G



Désignation		Code constructeur	Ref FHS
Entretoise de patin		ANTEO	4012350G
Entretoise de patin		ANTEO	4012350H
Palier de crémaillère de rétraction		ANTEO	4012355H
Galet de rétraction		ANTEO	4012396G
Galet de retraction Ø76,7mm		ANTEO	4012396H
Kit galets de retraction gamme ZS		ZEPRO	4012412G
Entretoise moteur hydraulique Ø25 Ø12.5 Lg 55mm		ZEPRO	4012428G
Arbre de transmission (central)		ANTEO	4012569G



Désignation		Code constructeur	Ref FHS
Arbre de transmission (extérieur)		ANTEO	4012570G
Bride fixation cremailere		ANTEO	4013032G
Mâchoire de frein hydraulique élément supérieur		ANTEO	4013035G
Mâchoire de frein hydraulique (élément inférieur)		ANTEO	4013036G
Support moteur hydraulique		ANTEO	4013037G
Bouchon plastique de glissière		ANTEO	4114167G
Bouchon de rail		ZEPRO	4114189G
Axe arbre rétraction extérieur Lg 695mm coté moteur hydraulique		ZEPRO	4116304G





Désignation		Code constructeur	Ref FHS
<p>Axe arbre de rétraction extérieur Lg 915mm coté moteur hydraulique - concept tube citron (renforce rigidité de l'ensemble)</p>		ZEPRO	4116304H 
<p>Axe arbre de rétraction intérieur Lg1091mm</p>		ZEPRO	4116305G
<p>Axe arbre de rétraction intérieur Lg 935mm coté opposé au moteur hydraulique - concept tube citron (renforce rigidité de l'ensemble)</p>		ZEPRO	4116305H 
<p>Palier axe de renvoi</p>		ZEPRO	4116356G
<p>Support de barre anti-encastrement</p>		ZEPRO	4122049G
<p>Cale d'usure</p>		ZEPRO	5221033G
<p>Patin de glissement avant</p>		ANTEO	5229056G
<p>Patin de glissement avant</p>		ANTEO	5229056H











Désignation		Code constructeur	Ref FHS
Patin de glissement arrière		ANTEO	5229057G
Patin de glissement arrière		ANTEO	5229057H
Patin de glissement		ANTEO	5229074C
Patin de glissement		ANTEO	5229074G
Chaîne équipée Lg 1500 mm pas de 19.05 pour rail < Lg1645mm		ZEPRO	5311006H
Chaîne pas de 19.05 vendu au ml		ZEPRO	5311007H
Attache rapide pas de 19.05		ERHEL HYDRIS ZEPRO	5311008H
Arbre de retraction assemble tube en acier (config tube citron Ø24mm)-finition zingage blanc		ANTEO	5316005H 



Désignation		Code constructeur	Ref FHS
Kit galets acier Ø98x937H7 ep20mm		ZEPRO	6011171H
Kit fixation cremailere		ANTEO	6011267G



Désignation		Code constructeur	Ref FHS
Axe Ø40 Lg 58mm		ANTEO	4012154C
Axe aluminium Ø20mm Lg 2500mm		ANTEO MBB INTER ZEPRO	4012361H
Axe Ø35 Lg utile 122mm axe equipe a plaquette amovible + graisseur		ANTEO ERHEL HYDRIS	4116010H 
Axe Ø30 Lg utile 36mm + M20 axe à tête hexagonale + rondelle et ecrou - avec graisseur		ZEPRO	4116031C
Axe Ø30 Lg utile 78mm +M20 axe à tête hexagonale + rondelle et ecrou - avec graisseur		ZEPRO	4116032C
Axe Ø25 Lg utile 170mm +M20 écrou à tête hexagonale + rondelle et ecrou - sans graisseur		ZEPRO	4116033C
Axe Ø30 Lg utile 79mm axe à plaquette amovible - avec graisseur		ANTEO	4116135G
Axe Ø25 Lg utile 36mm +M20 axe a tete hexagonale + ecrou + graisseur		ZEPRO	4116233H



Désignation	Code constructeur	Ref FHS
<p>Axe a roulette equipe axe Ø30mm Lg ss plaquette 105mm + M20</p>	ZEPRO	4116294C
<p>Axe Ø30 Lg totale 115mm Axe a plaquette soudee - Lg utile 106mm</p>	ZEPRO	4116317C
<p>Axe Ø30 Lg 177mm axe a plaquette soudee</p>	ZEPRO	4116318C
<p>Axe Ø30 Lg 131mm</p>	ZEPRO	4116319C
<p>Axe Ø30 Lg 360mm axe a plaquette amovible + 1 point de graissage</p>	ANTEO	4116320G
<p>Axe Ø30 Lg utile 42mm axe à plaquette amovible- avec un graisseur</p>	ANTEO	4116321G
<p>Axe Ø30 Lg utile 124mm axe à plaquette amovible - avec un graisseur</p>	ANTEO	4116326G
<p>Axe Ø30 Lg utile 170mm axe a plaquette soudee - avec graisseur</p>	ZEPRO	4116354G



Désignation		Code constructeur	Ref FHS
Axe Ø25 Lg utile 55mm axe a plaquette soudee - avec graisseur		ZEPRO	4116355G
Axe Ø25 Lg utile 62mm axe a plaquette soudee - 1 graisseur		ZEPRO	4116393C
Axe Ø25 Lg utile 155mm + entretoise axe a plaquette soudee - 2 points de graissage		ZEPRO	4116394C
Axe Ø30 Lg utile 81mm + M24 axe à tête hexagonale + ecrou - avec graisseur		ZEPRO	4116399C
Axe Ø30 Lg utile 81mm + M24 axe à tête hexagonale + rondelle et ecrou - avec graisseur		ZEPRO	4116399G
Axe Ø30 Lg utile 81mm + M24 axe à tête hexagonale + plaquette amovible + rondelle et ecrou - sans graisseur		ZEPRO	4116399H 
Axe Ø30 Lg utile 123mm axe à goupille Ø10mm		ANTEO	4116402C
Axe Ø30 Lg utile 123mm goupille Ø10mm		ANTEO	4116402G



Désignation	Code constructeur	Ref FHS
Axe Ø30 Lg utile 84mm axe a goupille	ANTEO	4116409C
Axe Ø30 Lg utile 84mm axe a goupille	ANTEO	4116409G
Axe Ø30 Lg utile 63mm axe a goupille	ANTEO	4116410C
Axe Ø30 Lg utile 63mm axe a goupille	ANTEO	4116410G
Axe Ø30 Lg utile 74mm axe a goupille	ANTEO	4116411C
Axe Ø30 Lg utile 74mm axe à goupille Ø10mm	ANTEO	4116411G
Axe Ø30mm Lg utile 190mm axe a tete hexagonale + rondelle + écrou M24 - Lg totale 220mm	ZEPRO	4116413C
Axe Ø30 Lg utile 307mm + M16 axe a goupille Ø10 (pour plateforme) - ss graisseur	ANTEO	4116478G









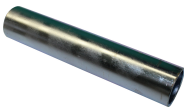

Désignation	Code constructeur	Ref FHS
<p>Axe Ø30/Ø35mm Lg utile 69mm + M24 axe à tête hexagonale + rondelle et ecrou - avec graisseur</p>	ZEPRO	4116507G
<p>Axe Ø30/35 Lg utile 69mm + M24 axe à tête hexagonale + rondelle et ecrou - avec graisseur</p>	ZEPRO	4116507H
<p>Axe Ø30mm Lg utile 140mm + M24 axe à tête hexagonale + ecrou - sans graisseur</p>	ZEPRO	4116512C
<p>Axe Ø30mm Lg utile 140mm + M24 axe à tête hexagonale + rondelle et ecrou - sans graisseur</p>	ZEPRO	4116512G
<p>Axe Ø30 Lg utile 140 mm + M24 axe à tête hexagonale + rondelle et ecrou - sans graisseur</p>	ZEPRO	4116512H 
<p>Axe Ø30 Lg utile 62mm + M24 axe a tête hexagonale+rondelle et ecrou - avec graisseur</p>	ZEPRO	4116513G
<p>Axe Ø30 Lg utile 62mm + M24 axe a tête hexagonale+rondelle et ecrou - avec graisseur</p>	ZEPRO	4116513H 
<p>Axe Ø30 Lg utile 145mm axe à plaquette soudee - sans graisseur</p>	ZEPRO	4116539G



Désignation		Code constructeur	Ref FHS
<p>Axe Ø30 Lg utile 145mm axe à plaquette amovible- sans graisseur</p>		<p>ERHEL HYDRIS ZEPRO</p>	<p>4116539H </p>
<p>Axe Ø30 Lg utile 53mm axe à plaquette amovible - avec un graisseur</p>		<p>ANTEO</p>	<p>4116548G</p>
<p>Axe Ø30/35 Lg utile 106mm + M24 axe à plaquette soudee et ergot + ecrou</p>		<p>ZEPRO</p>	<p>4116552C</p>
<p>Axe Ø30 Lg utile 307mm + M10 axe à goupille Ø10 (pour plateforme) sans graisseur</p>		<p>ANTEO</p>	<p>4116555G</p>
<p>Axe Ø30/35 Lg 81,5 mm axe à tête hexagonale + rondelle et ecrou - avec graisseur</p>		<p>ZEPRO</p>	<p>4116567G</p>
<p>Axe Ø30 Lg utile 120mm + M24 axe à plaquette soudee avec ergot + ecrou</p>		<p>ZEPRO</p>	<p>4116597C</p>



Désignation		Code constructeur	Ref FHS
Entretoise métal d.26xD.30 Lg.155			4012078H
Kit de bagues 2 bagues a collerette (45x36x30 Lg28mm) + 1 bague (40x30 Lg60mm)		ZEPRO	4117040C
Kit de 2 bagues épaulées Ø44/35/30mm - Lg25/2mm		ZEPRO	4117069C
Kit bagues (bras-plateau) pour 1 coté		ZEPRO	4118001H
Kit bagues Øext40mm Øint30mm Lg58mm pour crosses et pieds de cadre		ZEPRO	4118004G
Kit bagues Øext40mm Øint30mm Lg58mm pour crosses et pieds de cadre- matiere thermoplastique		ZEPRO	4118004H
Bague Ø30mm Lg20mm		ANTEO ERHEL HYDRIS	5210002
Bague Ø30mm Lg25mm		ANTEO ERHEL HYDRIS	5210003



Désignation		Code constructeur	Ref FHS
Bague Ø30 Lg30mm		ANTEO ERHEL HYDRIS	5210004
Bague Ø30mm Lg40mm		ANTEO ERHEL HYDRIS	5210005
Bague autolubrifiante Ø35mm Lg30mm		ANTEO DHOLLANDIA ERHEL HYDRIS	5210007
Bague autolubrifiante Ø35 Lg50mm		DHOLLANDIA ERHEL HYDRIS	5210008
Bague autolubrifiante Ø25 Lg30mm		DHOLLANDIA ZEPRO	5210012
Bague Øext40mm Øint30mm Lg58mm avec rainure centrale pour graissage - matière thermoplastique		ZEPRO	5210059C
Bague Øext40mm Øint30mm Lg58mm avec rainure pour graissage		ZEPRO	5210059G
Bague 30-15 P20		ANTEO	5210076









Désignation		Code constructeur	Ref FHS
<p>Entretoise de palier Ø45-Ø35.5mm Lg25mm - Øint25.5mm - avec rondelle et vis</p>		ZEPRO	4116357G
<p>Entretoise de palier Ø45-Ø35.5mm Lg25mm - Øint25.5mm - avec rondelles et vis</p>		ZEPRO	4116357H
<p>Goupille mécanindus Ø5mm Lg50mm</p>		ZEPRO	5124027
<p>Goupille mécanindus Ø8mm Lg50mm</p>		ZEPRO	5124028
<p>Goupille fixation d'axe Ø10mm</p>		ANTEO	5124031G





Désignation	Code constructeur	Ref FHS
Pointe ALU 850 adaptable	ZEPRO	4113186H
	france hayon	



Désignation		Code constructeur	Ref FHS
Volet butée de roll 67X 900mm type PML - 3encoches 160x25mm		ZEPRO	4010333G
Patin de manoeuvre butée de roll équipé Patin inox + vis et écrous		ZEPRO	4011120H
Accessoires RS (entretoise nylon D.12)			4012325G
Axe patin de manoeuvre pour butée de roll acier		ZEPRO	4012560G
Douille filetee pour butée de roll-Ø12mm Lg63mm		ZEPRO	4012561G
Axe de butée de roll gauche		ZEPRO	4012564G
Axe de butée de roll droit		ZEPRO	4012565G
Axe de manoeuvre butée de roll		ZEPRO	4012566G



Désignation		Code constructeur	Ref FHS
Quincaillerie pour B.R.		ZEPRO	4012580G
Taquet de butée de rolls Lg 900mm ouverture à 30°		ZEPRO	4013076G
Taquet de butée de rolls Lg 900mm equipe ouverture à 30°		ZEPRO	4013076H
Kit de 2 taquets alu Lg 800mm		ANTEO	4115019G
Taquet de manoeuvre gauche		ZEPRO	4115063C
Taquet de manoeuvre gauche		ZEPRO	4115063G
Taquet de manoeuvre droite		ZEPRO	4115065C
Taquet de manoeuvre droite		ZEPRO	4115065G



Désignation	Code constructeur	Ref FHS
Kit butees de rolls acier adaptable sur plateau acier et alu - auget 850x160xep25mm		4115070H 
Profil alu 100mm pour butée de roll	ZEPRO	4115133G
Ressort de butee de roll	ZEPRO	5313074G
Ressort de butée de roll	ZEPRO	5313077G
Ressort de butee de roll Øfil4mm - Lg165mm	ZEPRO	5313077H
Ressort de butée de roll 30x95 - 2mm	ANTEO	5313087C
Ressort de butée de roll 30x95 - 2mm	ANTEO	5313087G
Ressort de butée de roll	ZEPRO	5313110C









Désignation		Code constructeur	Ref FHS
Ressort de butée de roll		ZEPRO	5313110G
Ressort de butée de Roll.		ANTEO	5313112G
Ressort de butée de roll		ZEPRO	5313113G
Ressort patin de manoeuvre pour butee de roll		ZEPRO	5313119G
Ressort de butée de roll		ZEPRO	5313122G
Ressort de butée de roll		ZEPRO	5313123G
Ressort de butée de roll		ZEPRO	5313124G
Kit butees de roll 900mm		ZEPRO	6011268G

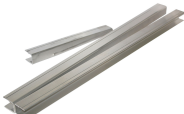

Désignation		Code constructeur	Ref FHS
Rive de pointe droite 50X42X50mm int-Lg 355mm		MIC ZEPRO	4011130G
Rive de pointe gauche 50X42X50mm int-Lg 355mm		MIC ZEPRO	4011131G
Rive de talon coté droite 144x54mm		ANTEO	4011136G
Rive de talon coté gauche 144x54mm		ANTEO	4011137G
Rive de pointe plastique gauche Lg 260mm		ZEPRO	4011140G
Rive de pointe droite 30x40x30mm Lg300mm F3CL 080		ANTEO	4011144C
Rive de pointe droite 30x40x30mm Lg300mm F3CL 080		ANTEO	4011144G
Rive de pointe gauche 30x40x30mm Lg300mm F3CL080		ANTEO	4011145C



Désignation	Code constructeur	Ref FHS
<p>Rive de pointe gauche 30x40x30mm Lg3000mm F3CL080</p>	<p>ANTEO</p> 	4011145G
<p>U alu pour rive de plateforme 35x40x35mm Lg2000mm ep3mm</p>	<p>ANTEO ZEPRO</p> <p>francehayon</p>	4011146C
<p>Rive de plate-forme en U 30x40x30xEp.3 L.2m 30x40x30xep3mm Lg2000mm</p>	<p>ANTEO</p> <p>francehayon</p>	4011146G
<p>Kit rives de plateforme (ep30mm) coté droite - 2 longueurs 800mm (45x40x45mm) + rive de pointe 350mm</p>	<p>ZEPRO</p> 	4011245G
<p>Kit rives de plateforme (ep30mm) coté gauche - 2 longueurs 800mm (45x40x45mm) + rive de pointe 350mm</p>	<p>ZEPRO</p> 	4011246G
<p>Rive latérale de plateforme 1170mm pour profil ep40mm - 35x45x35mm -</p>	<p>ZEPRO</p> 	4011356G
<p>Rive de pointe droite Lg245mm - Ep40x30mm</p>	<p>ZEPRO</p> 	4011357G
<p>Rive de pointe gauche Lg 245mm - Ep40x30mm</p>	<p>ZEPRO</p> 	4011358G



Désignation		Code constructeur	Ref FHS
Rive latérale de plateforme 62x47x42mm Lg1000mm ep tole 2,5mm		ANTEO	4011457G
Pointe de rive droite 68x45x45mm ep3mm - Lg 303mm		ANTEO	4111034G
Pointe de rive gauche 68x45x45mm ep3mm - Lg 303mm		ANTEO	4111035G



Désignation		Code constructeur	Ref FHS
Verrouillage route		ZEPRO	4115097G
Cremone de verrouillage		ZEPRO	5012026G
Cremone verrouillage route		ANTEO	5012027G
Kit Verrou court pour plate forme alu		ANTEO	6011157G





Désignation		Code constructeur	Ref FHS
Butée de hayon Ø50mm-ep20mm-M10		ANTEO	5315022C
Butée de hayon Ø50mm-ep20mm-M10		ANTEO	5315022G
Butoir Ø25mm ep25mm		ANTEO	5315023G



Désignation		Code constructeur	Ref FHS
Bloc nylon barre torsion 30.5x25.5mm Lg60mm		ZEPRO	4010637G
Bloc nylon barre torsion 31x25,50 Lg31,5mm - passage Ø11mm		ZEPRO	4010638G
Kit patins d'usure éléments pour plate-forme		ZEPRO	4011162C
Kit patins usure éléments pour plateforme		ZEPRO	4011162G
Jeu de 2 patins d'usure de plateforme		ZEPRO	4011271G
Jeu de 2 patins d'usure de plateforme		ZEPRO	4011271H
Bouchon de B.A.E. Ø100mm		ANTEO DHOLLANDIA ERHEL HYDRIS	4114021H
Bouchon de barre anti-encastrement		ZEPRO	4114080G



Désignation		Code constructeur	Ref FHS
Bouchon Ø115mm		ANTEO	4114161G
Bouchon Ø115mm		ANTEO	4114161H
Bouchon de barre anti encastrement Ø 120mm		ANTEO	4114243H
Bouchon de barre anti encastrement 100x50mm ext		ANTEO	4114256G
Bouchon de barre anti encastrement 100X50mm		ANTEO	4114256H
Axe Ø20 Lg 123 mm pour barre de torsion 32934 et 935TL			4116581G
Charnière aluminium pour liaison talon pointe-montage uniquement sur pointe conception HYDEM		ZEPRO	5013046H
Charnière aluminium de pointe alu version pointe 7 charnières		ZEPRO	5013052G



Désignation		Code constructeur	Ref FHS
Galet de plateforme Ø71 x 12.5 ép 28 ertalon		ANTEO	5015009C
Galet ertalon Ø85xØ55 ep30mm		ZEPRO	5015027C
Roulette Ø100mm-ep30mm		ANTEO	5015030H
Galet ertalon pour plate forme Ø93xØ55 Ep30mm		ZEPRO	5015031C
Galet ertalon pour plate forme Ø93xØ55 Ep30mm		ZEPRO	5015031G
Rouleau de plateforme Ø80 Øint30.8mm ep35mm		ANTEO	5015033C
Galet de plateforme Ø82XØ30X35mm		ANTEO	5015033G
Galet ertalon pour plate forme Ø93mmxØ55mm ép49.5mm		ZEPRO	5015035C











Désignation		Code constructeur	Ref FHS
Galet de roulement acier pour plateforme Ø93x55mm ép50mm		ZEPRO	5015036H 
Rondelle de calage		ZEPRO	5117019G
Entretoise galet d'appui Ø60/55 - Lg54mm - pour axeØ30mm		ZEPRO	5131009C
Entretoise galet d'appui Ø60/55mm-Lg54mm-pour axeØ30mm		ZEPRO	5131009G
Entretoise galet d'appui Ø60-55mm - Lg54mm pour axe Ø30		ZEPRO	5131009H
Entretoise galet d'appui Ø60/55 Lg34mm-pour axeØ30mm		ZEPRO	5131010C
Entretoise galet d'appui Ø60/55 Lg34mm-pour axeØ30mm		ZEPRO	5131010G
Bague entretoise nylon ouverte pour barre torsion - Ø32 Lg50mm		ZEPRO	5210194G



Désignation		Code constructeur	Ref FHS
Bague entotoise alu Ø25/20 Lg35mm		ZEPRO	5210215G
Arrêtoir plastique fixation sur flasque		ZEPRO	5229064G
Compas à gaz EA ouvert:705mm		ANTEO	5310001G
Compas à gaz EA ouvert:705mm		ANTEO	5310001H
Compas à gaz Ø10 x 22mm oeil Ø8mm EA605mm		ANTEO	5310005G
Ressort de torsion droit pour ZR Ø fil 14mm		ZEPRO	5313106G
Ressort droit de plateforme REP15 Lg200mm-Ø57mm-Øfil12mm		ANTEO	5313108C
Ressort droit de plateforme REP15 Lg200mm-Ø57mm-Øfil12mm		ANTEO	5313108G



Désignation		Code constructeur	Ref FHS
Ressort gauche de plateforme REP15 Lg200mm-Ø57mm-Øfil12mm		ANTEO	5313109C
Ressort gauche de plateforme REP15 Lg200mm-Ø57mm-Øfil12mm		ANTEO	5313109G
Barre de torsion Ø12mm Lg 1250mm		ANTEO	5313153C
Barre de torsion Ø12mm Lg 1250mm		ANTEO	5313153G
Barre de torsion Ø11mm Lg 1040mm - cote gauche		ZEPRO	5313189C
Barre de torsion Ø11 Lg 1040 mm coté droite		ZEPRO	5313191C
Jeu de 2 drapeaux rétro réfléchissants		ANTEO	5414170G
Kit barre de torsion barre en Ø12mm Lg 1250mm		ANTEO	6011263G